

LT3QOG250-00-X-X-24V

Beam Splitter Assembly Guideline

1. Un-assemble screw for the following;

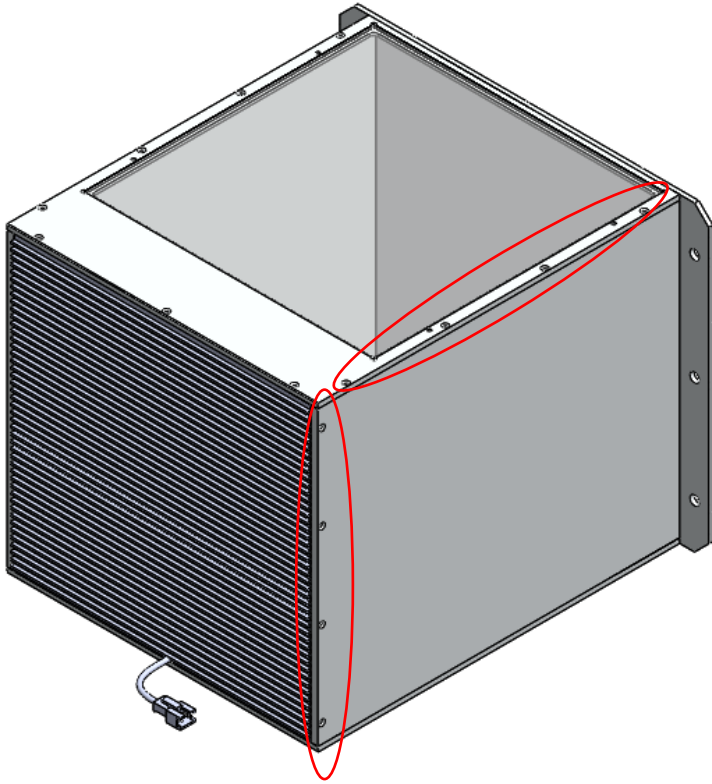

Open screw M2 x8pcs

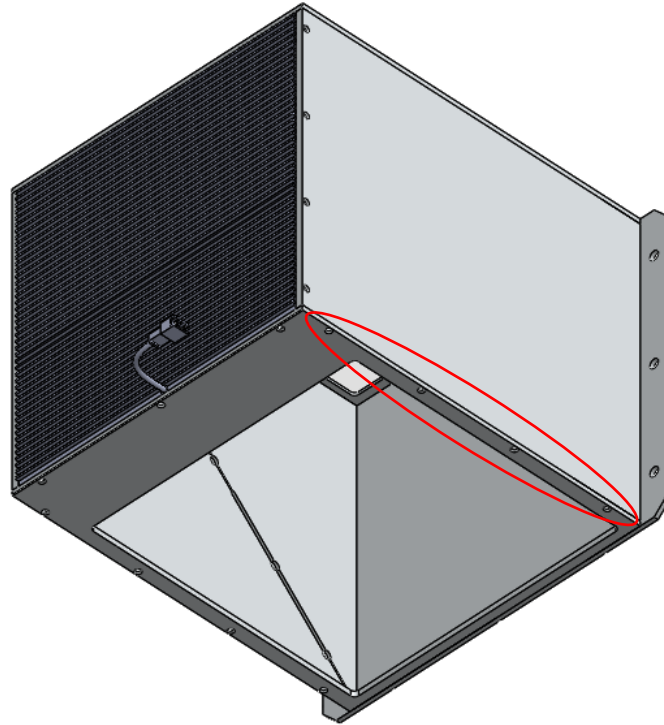

Open screw M2 x4pcs

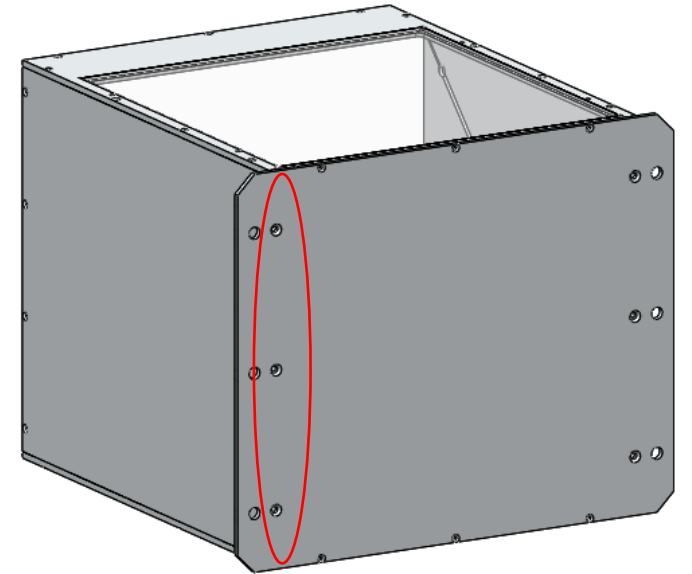

Open screw M3 x3pcs

2. Take out the side plate.

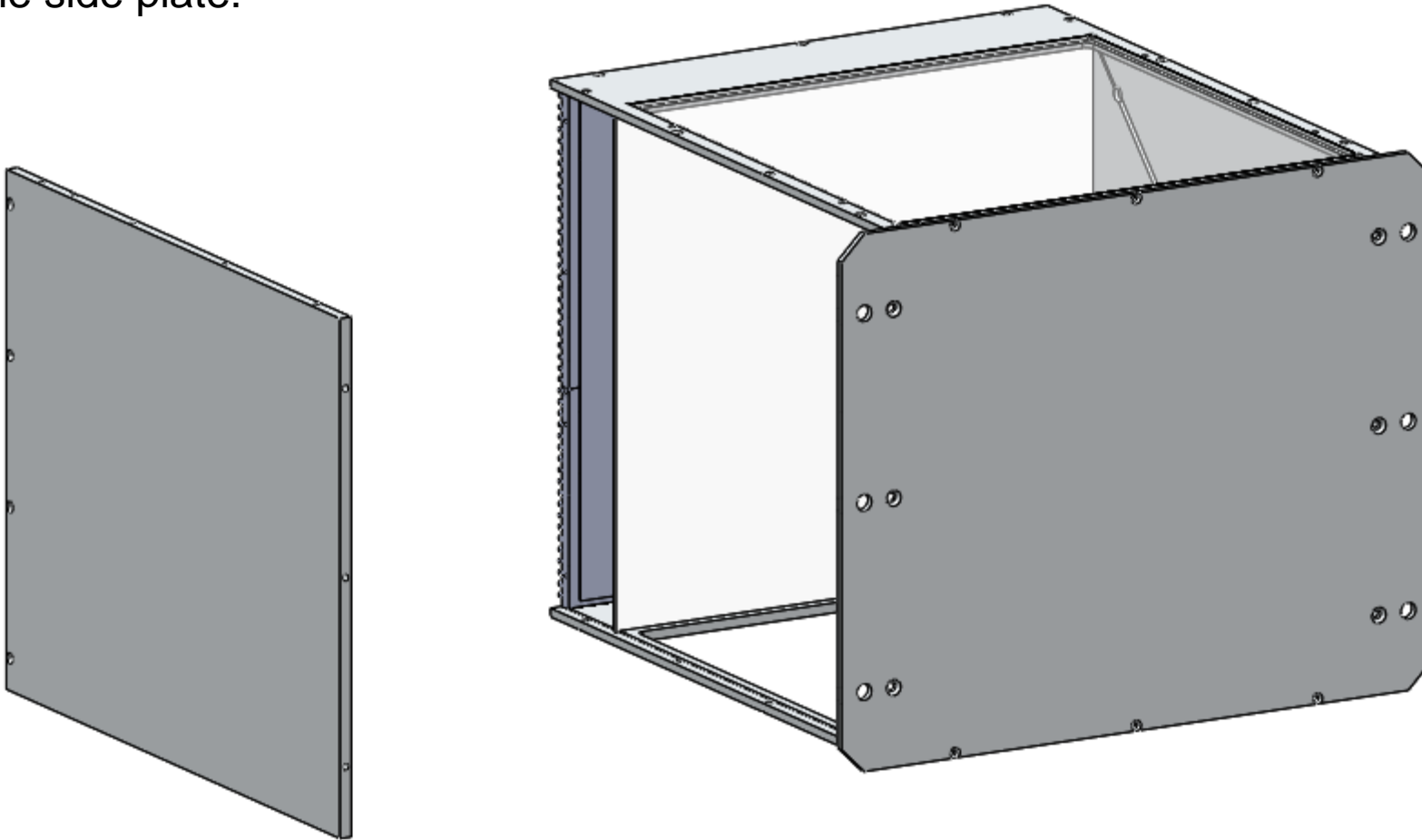

3. Flip casing position for the following picture.

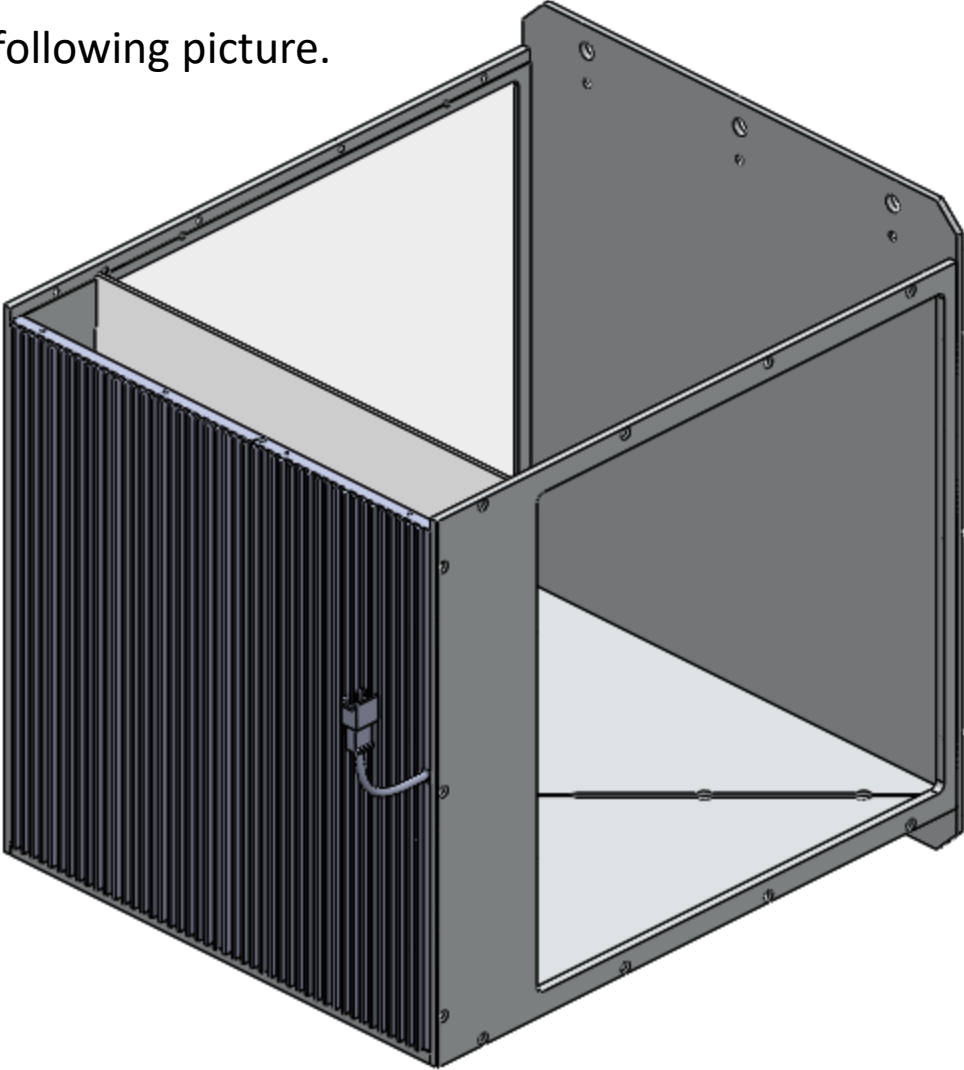

4. Install Beam splitter for following;

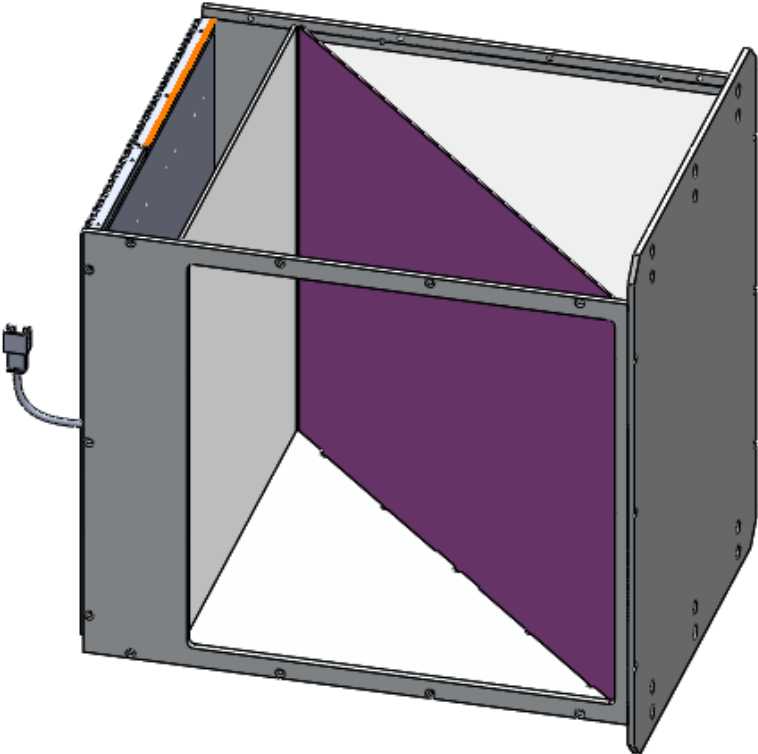
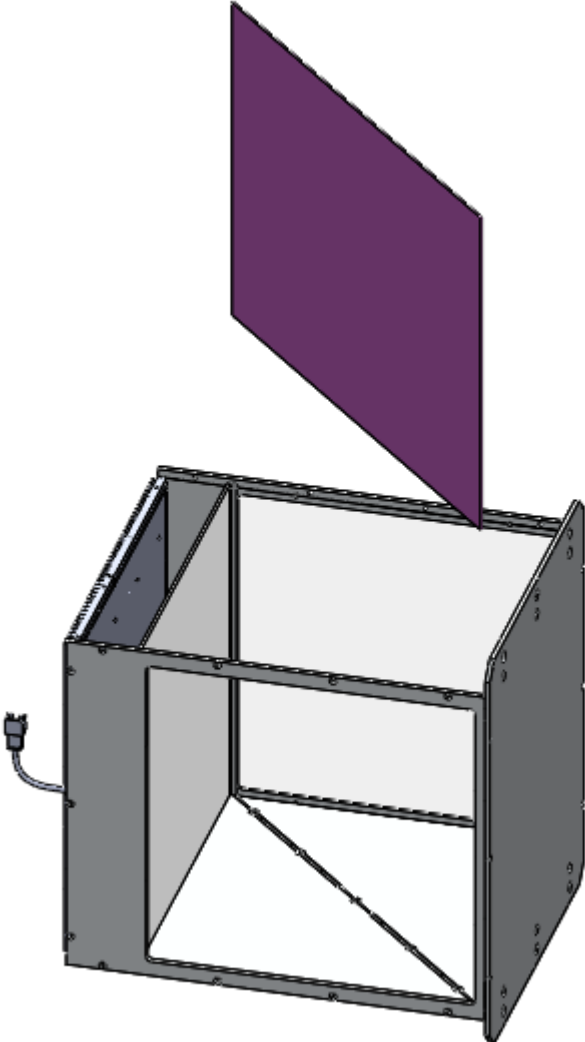

BEAM SPLITTER

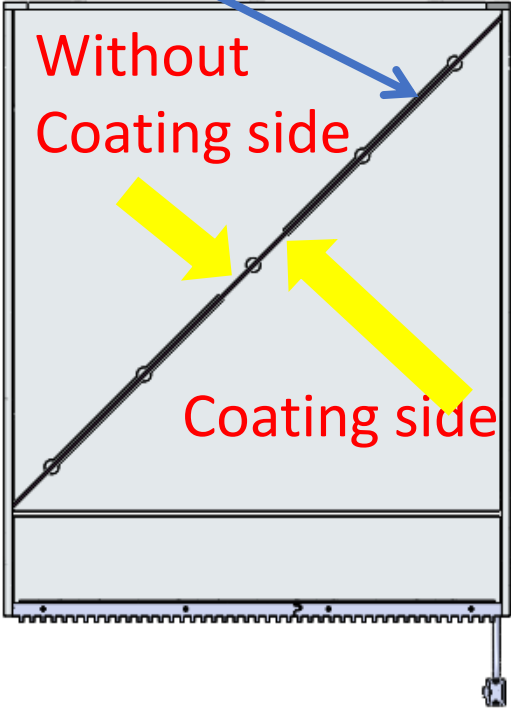

5. Put into the slot as the picture showing.

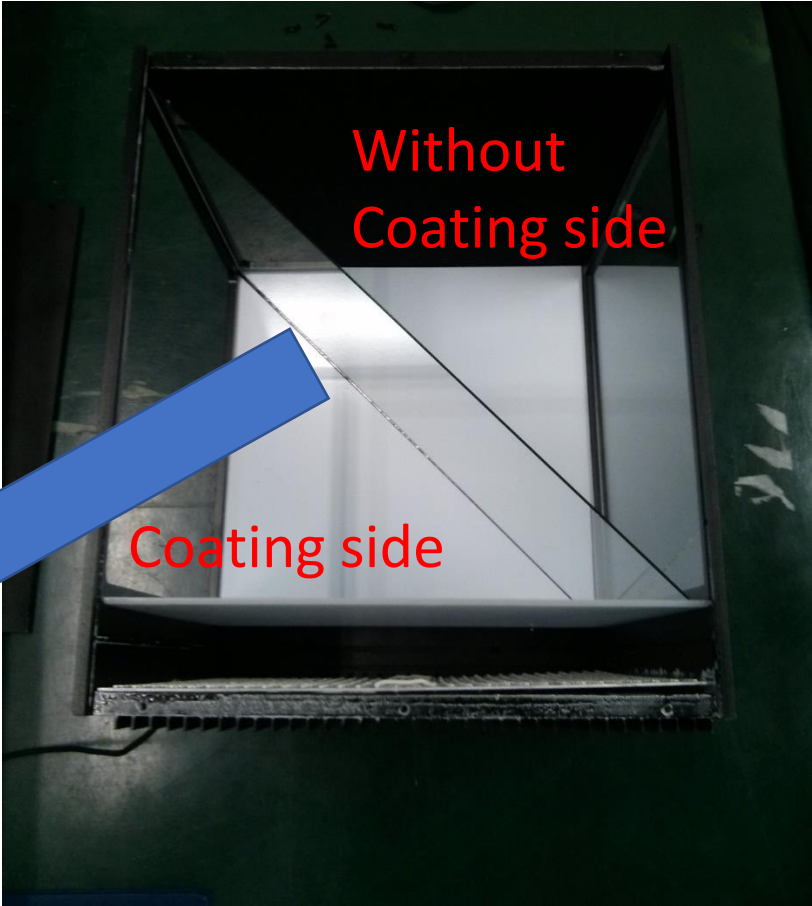

6. Side plate place back on the casing.

Warning: Be careful the beam splitter with side plate

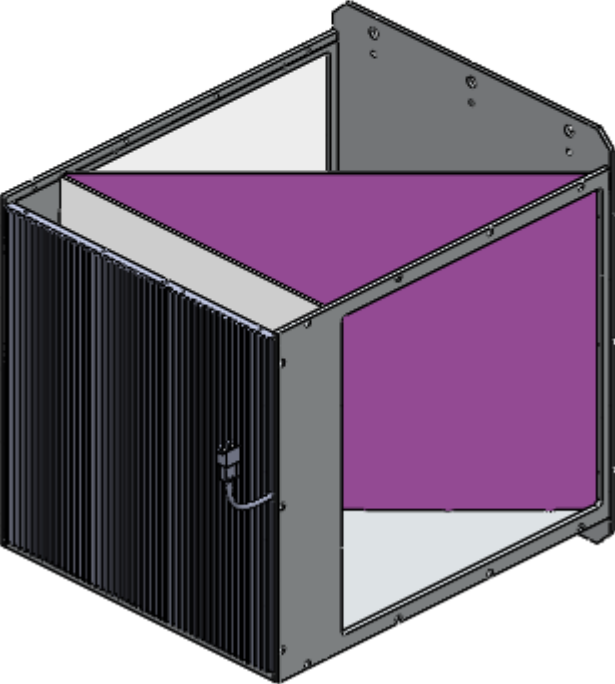
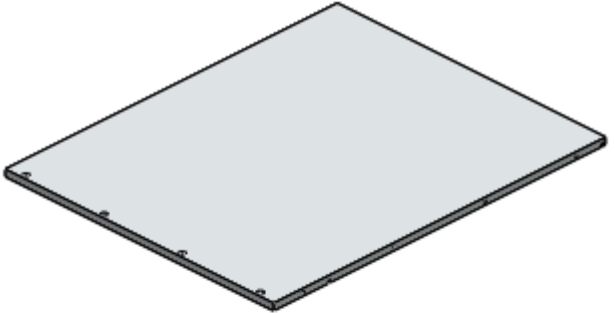

Make sure plate in slot

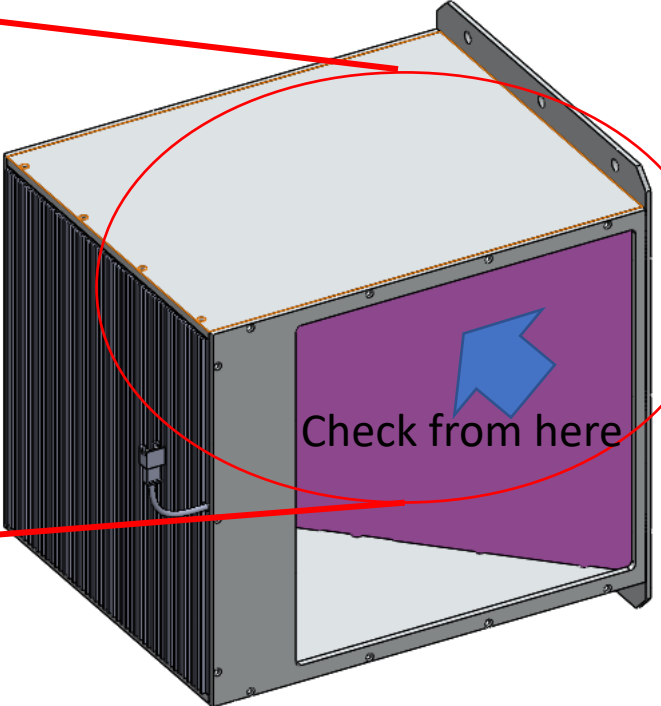
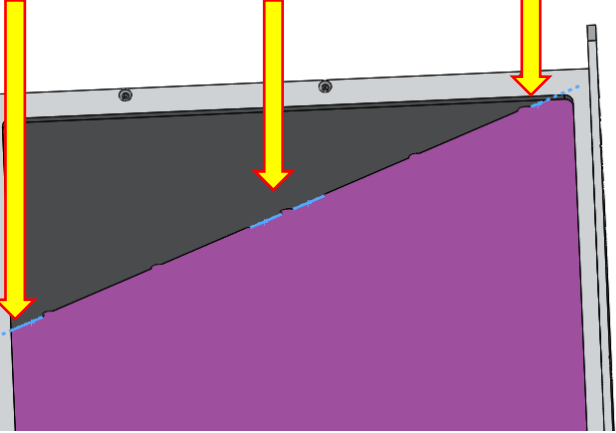

7. Assembly all screw on the casing.

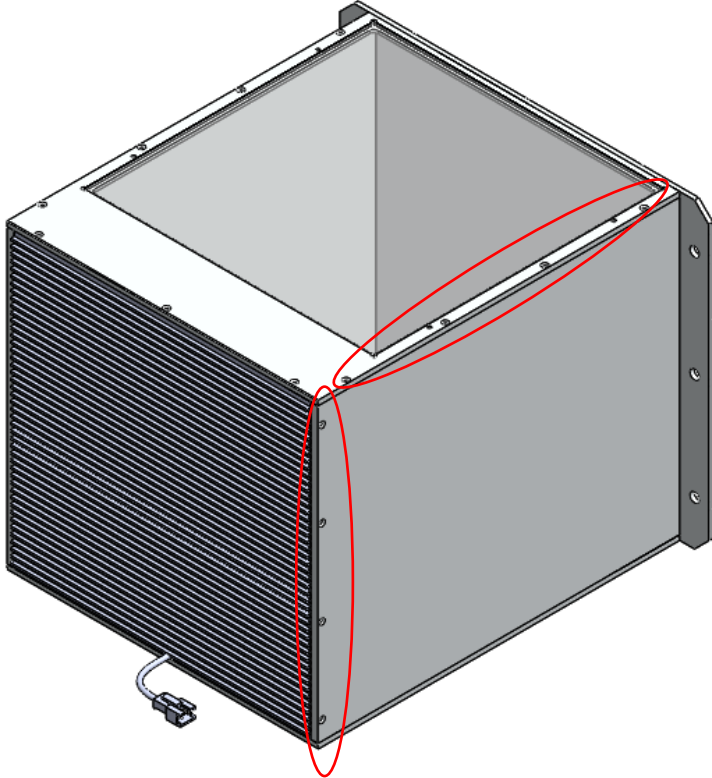

Assemble screw M2 x8pcs

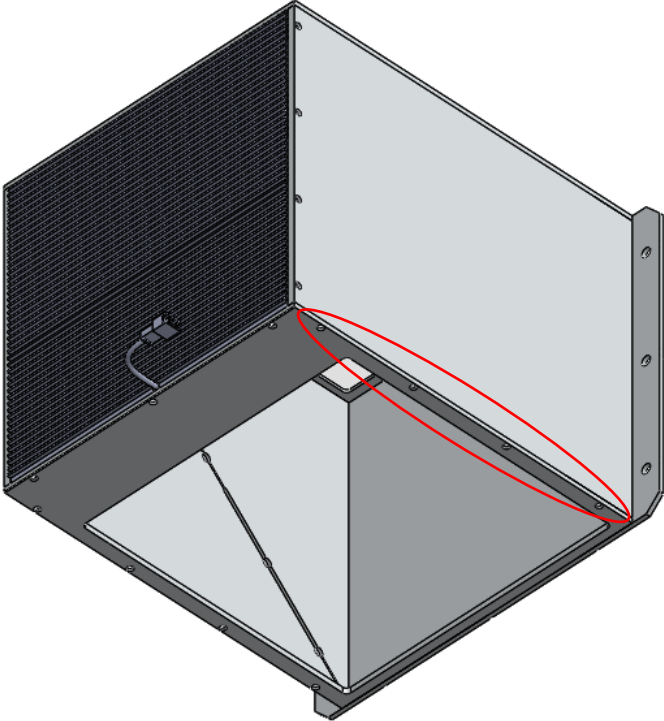

Assemble screw M2 x4pcs

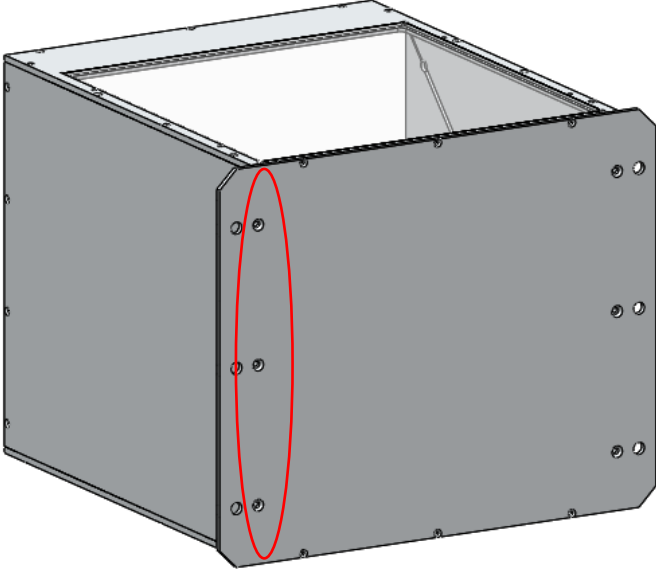

Assemble screw M3 x3pcs